

Water Treatment



ATHENA BX 12V

ELECTROMAGNETIC DOSING PUMPS



Main characteristics

- PVDF PUMP HEAD suitable for chemicals used in the Industrial, Waste Water Treatment and Potable Water applications
- CERAMIC BALL full chemical compatibility
- PTFE DIAPHRAGM unique life expectancy and compatibility with most chemicals
- STEADY DOSING Stabilized Multi Power Supply 12VDC
- reduced consumption
- QUICK CONNECTIONS
- MANUAL PRIMING VALVE
- IP65 PROTECTION
- POWER-ON and LEVEL ALARMS LED
- 0÷20%, 0÷100% double manual flow regulation
- Anti-seepage system

Water Treatment



Athena – Performance data

PERFORMANCES TEST HAS BEEN DONE AT AMBIENT TEMPERATURE, WITH WATER, AT 1,5 mt SUCTION HEIGHT

Athena – Performance data

FLOW RATES	PRESSURES	CC/IMP.	CONNECTIONS	STROKES/MIN.	CONSUMPTION	WEIGHT
3 l/h	10 bar	0,25	4x6	200	6,5 watt	3 kg
4 l/h	8 bar	0,33	4x6	200	6,5 watt	3 kg
5 l/h	5 bar	0,42	4x6	200	6,5 watt	3 kg

PERFORMANCES TEST HAS BEEN DONE AT AMBIENT TEMPERATURE, WITH WATER, AT 1,5 mt SUCTION HEIGHT

Anti-seepage system

The anti-seepage system, is a solution to prevent the intrusion of chemical product inside the pump: leakage and chemical intrusion can happen when the O-ring is damaged or consumed by regular use.

This device is integrated in the hydraulic part, between pump head and body, behind the diaphragm: the outgoing collection channel of the anti-seepage device (see below blue arrow) collects the leakage and expel it out. When the leakage is visible, the operator can proceed either tightening the 4 bolts of the head (4Nm torque) or disassembling the head and inspect it in order to understand leakage causes .

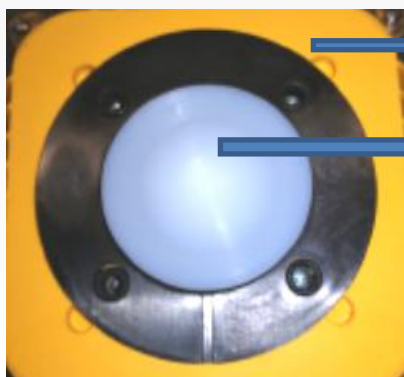

Anti-seepage device

collection channel

Water Treatment



Main applications

- Electroplating industry, Pickling, Degreasing and metal treatments generally
- Cooling Tower
- Potable water application
- Reverse osmosis application
- Paper industry
- Ceramic industry

Example of installation





Water Treatment

Installation kit



Accessories

AC.VSA (ATHENA.1 .2 .3)	
	<ul style="list-style-type: none"> • PvdF Pump head with automatic bleed valve • Flow reduction, according to the quantity of air in the liquid



AC.VM PVDF	
	<ul style="list-style-type: none"> • Multifunction valve, anti-syphon, backpressure, safety • PVDF body, PTFE membrane • Adjustable Pressure 0-5 bar • Relief Pressure 0-18 bar

AC.SF	
	<ul style="list-style-type: none"> • PVC Flow sensor • FPM Seals • 4x6 / 8x12 connections

AC.VS	
	<ul style="list-style-type: none"> • Back-pressure valve up to 10 bar • PTFE diaphragm

AC.ST	
	<ul style="list-style-type: none"> • Horizontal base mounting bracket

PRIMING AID	
	<ul style="list-style-type: none"> • Capacity: 300 ml • PVC body • FPM seals • Connections: 4x6mm - 8x12mm

AC.VIE	
	<ul style="list-style-type: none"> • Extractable injection valve with ball valve PVC 1/2" g.m. IN - 1/2" g.m. OUT
	<ul style="list-style-type: none"> • Extractable injection valve PVC 1/2" g.m. IN - 1/2" g.m. OUT

Water Treatment



Dimensional drawings

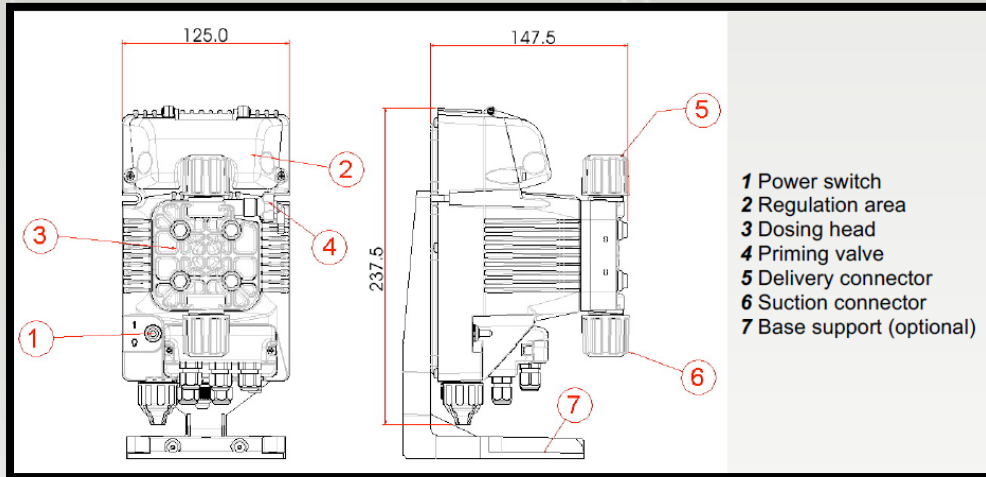

Plumbing

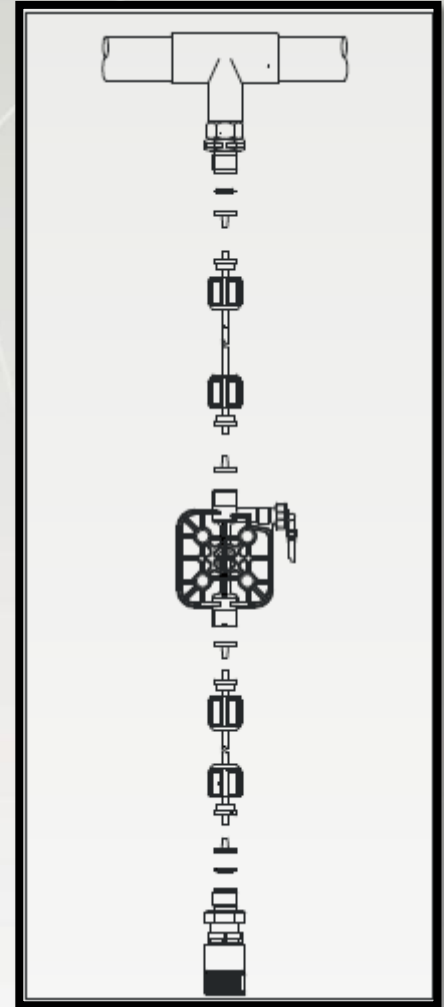

Fixing templates

